

## 300 Watt — PLY300W Series

CONSTANT CURRENT LED DRIVER WITH 0-10V or PWM DIMMING

PC & NFC Programming, Flicker-Free, Deep Dimming.

Class 2 Isolated Dimming US & CN, UL8750, UL CLASS P

PLY driver is a high-performance LED driver that provides smooth, continuous <1% dimming and dim to off for virtually any LED fixture. Full range 1-100% dimming is DC output, and dimming below 15% is not PWM output. It is the most versatile LED driver offered today due to its compatibility with a wide variety of LED arrays, multiple form factors, and numerous control options.

Module Temperature Protection (MTP) supports thermal feedback and robust thermal manage. LED module working temperature can automatically be reduced by the PLY driver, setting by software of the output current decrease depending on the measured NTC value to avoid decreased lifetime of the LED module.

LED codes configure dimming curve, LED current and more. Programmable solution that offer ultimate design flexibility. GUI interface for programmable output current using. The driver also has NFC wireless programmable function, it's designed to give OEMs ultimate flexibility. With wide operating windows and simple wireless programming, the drivers make it easy for luminaire manufacturers to design luminaires of different sizes and lumen levels for outdoor applications.

### Key Features

- Drive Mode: Constant Current, Dimming, Programmable.
- Technology: Active PFC Corrected 2-Stage Switch Mode.
- Input Voltage: 120 to 277 Vac (UL). 220 to 240 Vac (ENEC).
- Output Power: 300 Watt Max.
- Dimming: Smooth & Continuous Dimming from 1%<sup>Q</sup> to 100%.  
LEDs turn on to any dimmed level without going to full brightness.  
Constant Current Reduction (CCR) dimming methods.  
0-10V: 2-wire Analog / PWM Control Dimming (Isolated, Class 2).
- Output Voltage: 10 Vdc to 457 Vdc (With Auxiliary CV 12V or 24V Output).
- Output Current: 200 mA to 6700 mA (Set by PC or NFC programming).
- Efficiency: Up to 94%.
- Warranty: 5 years.

### Special Features

- Continuous, flicker-free dimming from 1%<sup>Q</sup> to 100%, dim-to-off programmable, Minimum dimming programmable, Dimming curve programmable (Optional: linear, log).
- Dimming control is isolated for AC input and DC output.
- Programmable options: Output Current Soft-Start, Constant Lumen Output, End-of-life Indicator.
- Output current can be controlled by an external NTC, Protection temperature programmable.
- Output current can be set by PC or NFC (wireless programming). PC and NFC programming can only be one of the optional.
- A rated lifetime of 50,000 hours @ Tc = 75 °C.
- The standby power is lower than 0.4W @120V AC Input and 0.5W @ 277V AC input.
- Safety: UL8750-2018 SF, Class P, CSA22.2, EN61347. Safety isolation between primary and secondary.
- EMC: FCC 47CFR Part 15 Class B, EN55015.
- Inrush Current Limiting Circuitry: line to line 6 KV/3KA 8/20uS, line to earth (PG) 10 KV/2ohm 8/20uS. eliminates circuit breaker tripping, switch arcing and relay failure.
- Metal shell, Used with silicone potting. Meet the RoHs directive.
- IP67, NEMA4 compliant for Dry, Damp, Wet Locations.
- 100% performance tested with CHROMA 8000 system at YG factory.
- 100% burned in with program-control test system at YG factory, @ 50 °C.

Enclosure



Size	Unit	
	Inch	Millimeter
Case Length	11.53	293.0
Case Width	3.00	76.0
Case Height	1.62	41.1
Mounting Length	11.10	282.0



## Excellent LED Drivers

Sino-US joint venture

### Main Electrical Specification

Part Number	US & CN Class 2	Output Power (W)	Output Voltage (V)	Programmable Current Range Max. (mA)	Programmable Current Range at 300W output (mA)	Efficiency @ Max Load			Programming mode
						@120V	@230V	@277V	
PLY300W-55-C6700-YY-P-W-Z	No	300	10 - 55	1000 - 6700	5400 - 6700	90.5	92.5	93.0	PC or NFC
PLY300W-100-C4300-YY-P-W-Z	No	300	20 - 100	700 - 4300	2700 - 4300	90.5	92.5	93.0	PC or NFC
PLY300W-200-C3000-YY-P-W-Z	No	300	36 - 200	500 - 3000	1500 - 3000	91.0	93.0	93.5	PC or NFC
PLY300W-457-C1400-YY-P-W-Z	No	300	83 - 457	200 - 1400	650 - 1400	91.5	93.5	94.0	PC or NFC

#### Note:

- ◆ Product may be suffixed by "YY", where "YY" may be RD, RP, RN, RDNFC or blank, which mean different dimmer control function in secondary circuit.
    - RD, PC programming, 0-10V dimming. –RP, PC programming, PWM dimming. –RN, non programming, 0-10V dimming.
    - RDNFC, NFC programming, 0-10V dimming. Use the housing with antenna. –Blank, non dimming & non programming.
  - ◆ Product may be suffixed by "-P", which means suitable for UL listed & class P use while models.
  - ◆ Product may be suffixed by "-W", which means suitable for wet location use while models, without suffix "-W" are suitable dry/damp location use only.
  - ◆ Product may be suffixed by "Z", where "Z" may be 12, 24 or blank, which mean different auxiliary output in secondary circuit.
    - 12, auxiliary constant voltage output 12V/200mA. –24, auxiliary constant voltage output 24V/100mA. –Blank, non auxiliary output.
- ① The minimum dimming is less than 1%, when the programming current is 40-100% of the maximum current of the model.

### Programmable Parameters

Programmable Parameter	Programmable Minimum Value	Programmable Maximum Value	Factory Default	PC (NTC) Programmable	NFC (wireless) Programmable	Notes / Conditions
Output Constant Current 1	1000mA	6700mA	3000mA	YES	YES	PLY300W-55-C6700
Output Constant Current 2	1000mA	4300mA	3000mA	YES	YES	PLY300W-100-C4300
Output Constant Current 3	500mA	2800mA	3000mA	YES	YES	PLY300W-200-C3000
Output Constant Current 4	200mA	1400mA	1050mA	YES	YES	PLY300W-457-C1400
Disable Dimming	NO	YES	NO	YES	YES	
Dimming Curve	LINEAR	0%	N/A Fixed 100%	0%	YES	YES
	LOG	0%	N/A Fixed 100%	0%	YES	YES
NTC Minimum Ohms	1KΩ	10KΩ	2KΩ	YES	YES	For PC programmable products only.
NTC Minimum %out	~0%	100%	~10%	YES	YES	
NTC Maximum Ohms	2KΩ	10KΩ	6.3KΩ	YES	YES	
Output Current Soft-Start	N/A	N/A	OFF	YES	YES	
Constant Lumen Output	N/A	N/A	OFF	YES	YES	
End-of-life Indicator	N/A	N/A	OFF	YES	YES	

### Input Specifications

Parameter	Min.	Typ.	Max.	Notes / Conditions
Input Voltage	120 Vac	---	277 Vac	120, 220, 230, 240, 277 Vac Nominal Values
Input Frequency	47 Hz	50/60 Hz	63 Hz	50/60 Hz Nominal
Input AC Current	---	---	2.86 A	Measured at 120 Vac / 60Hz Input, Output Full Load.
	---	---	1.56 A	Measured at 230 Vac / 50Hz Input, Output Full Load.
	---	---	1.35 A	Measured at 277 Vac / 60Hz Input, Output Full Load.
Inrush Current ( Peak )	---	---	58 A / 3mS	Measured at 230 Vac / 50Hz Input, Output Full Load.
	---	---	70 A / 2mS	Measured at 277 Vac / 60Hz Input, Output Full Load.
Leakage Current	---	---	400 μA	Measured at 120 Vac / 60Hz Input, Output Full Load.
	---	---	750 μA	Measured at 277 Vac / 60Hz Input, Output Full Load.
THD	---	---	20%	Measured at 120, 230, 277 Vac Input, Output ≥ 45% Load.
Power Factor ( PF )	0.90	---	---	
Standby Power	0.3 W	0.4 W	0.5 W	Measured at 120, 230, 277 Vac Input, The output and auxiliary are no-load.

### Output Specifications

Parameter	Min.	Typ.	Max.	Notes / Conditions
DC Output Voltage	Per Table	Per Table	Per Table	Per Tables on Page 1
Output Constant Current	-5%	Per Table	+5%	Per Tables on Page 1



## Excellent LED Drivers

Sino-US joint venture

Output Power	---	---	Per Table	Per Tables on Page 1
Flicker Index ( Vpk-pk )	---	---	5% Vo	20MHz BW, Full load output in parallel with 0.1uF & 10uF CAP. Flicker Index is defined as [(Ymax-Ymin)/(Ymax+Ymin)] * 100%. Y may be V or I.
Flicker Index ( Ipk-pk )	---	---	5% Io	
Line Regulation	-3%	---	+3%	Measured at 120, 230, 277 Vac / 60Hz Input, Output Full Load
Load Regulation	-4%	---	+4%	Measured at 120, 230, 277 Vac / 60Hz Input
Start-up Time	---	400ms	500ms	Measured at 120, 230 Vac / 60Hz Input, Output Full Load
	---	350ms	500ms	Measured at 277 Vac / 50Hz Input, Output Full Load
Output Overshoot	-2%	---	+10%	Measured at 120, 230, 277 Vac Input, When power on or off

### Protection Specifications

Parameter	Min.	Typ.	Max.	Notes / Conditions
Output Short Circuit ( SCP )	---	---	---	No Damage. Auto recovery after short is removed.
Output Over Current ( OCP )	---	---	+10% Io	Constant Current Limiting circuit.
Output Over Voltage ( OVP )	---	---	120% Vo	No Damage. Auto recovery after short is removed.

### Dimming Specifications

Items	Parameter	Min.	Typ.	Max.	Notes / Conditions
Auxiliary Output	Output Voltage 12V or 24V (optional)	-10%	---	+10%	Voltage Margin: +/-10% of the standard value, 12V/200mA max, 24V/100mA max, Yellow Wire.
	Output Current (12V/24V)	0	100/50mA	200/100 mA	
0-10V Dimming	Input Absolute Voltage	-2.0 V	10 V	15 V	Purple Wire
	Output Source Current	20 uA	100 uA	200 uA	Purple Wire
	Output Current Range in 0-10V Dimming	1% <sup>①</sup>	---	100%	CCR output
	Output Current in 0-10V Pin Open	---	Normal	---	It's a constant current output with active PFC.
	Output Current in 0-10V Pin Short Circuit	---	Min.	---	CCR output
	Vdim @ Maximum Output Current	8.0 V	9.0 V	10.0 V	
	Vdim @ Minimum Output Current	1.0 V	1.2 V	1.5 V	
	Vdim @ Dim On Threshold	0.7 V	0.8 V	0.9 V	Vdim where output power changes from Standby to minimum.
Vdim @ Dim Off Threshold	0.4 V	0.5 V	0.6 V	As Vdim falls, output power changes from Minimum to Standby.	
PWM Dimming	Input Absolute Voltage	-2.0 V	10 V	15 V	
	Input Current on PWM pin	20 uA	100 uA	200 uA	
	PWM Frequency	200 Hz	1 KHz	1.5 KHz	
	PWM Duty	0 %	---	100%	
	Output Current Range in PWM Dimming	1%	---	100%	CCR output
	Output Current in PWM Pin Open	---	Normal	---	It's a constant current output with active PFC.
	Output Current in PWM Pin Short Circuit	---	Min.	---	CCR output

### General Specifications

Parameter	Typ.	Notes / Conditions
Cooling	Convection	
MTBF	340,000 hours	Measured at 120 Vac input, 100% Load and Tc=75° C (MIL-HDBK-217F).
Life Time	50,000 hours	
Product Noise	< 24 db	Class A, Not to exceed at 1 meter at any dim level.

### Environmental Specifications

Parameter	Min.	Typ.	Max.	Notes / Conditions
Case Temperature ( Tc )	-40 °C	---	+90 °C	Measured at location specified on case.
Operating Temperature ( Ta )	-40 °C	---	+50 °C	This is a reference range. Tc controls temperature range.
Storage Temperature ( Ts )	-40 °C	---	+85 °C	Non operating temperature range.
Operating Humidity	5% RH	---	95% RH	Relative Humidity. Non-condensing.
Vibration	5 Hz	---	55 Hz	2G, 10 minutes / 1 cycle, period 30 minutes, each along X, Y, Z axis.

## Safety Compliance

Safety Category	Standards / Notes
UL / cUL	UL8750, CAN/CSA C22.2 No. 250.13, UL Class P.
CE	EN 61347-1:2007+A1:2010+A2:2012, EN61347-2-13:2014, EN 62493:15
Withstand Voltage	Input to Output: 3750 Vac
Output / Dim	2.5KV
Enclosure / Ground - Input & output / NTC & Dim	2.0KV
Isolation Resistance	Input to Output: >10MΩ, 500Vdc @ 25°C, 70% RH
Aux Circuit	Aux are considered part of the secondary circuit.
0-10V Class 2 Isolated Dimming	DIM+ (Purple) / DIM- (Grey) are Class 2 Isolated from AC Input and DC Output.
FG	The metal case of the driver must be connected to earth ground (FG) in the end-use application.

## EMC Compliance

EMI Category	Standards
FCC	FCC 47CFR Part 15, ANSI C63.4: 2009
CE	EN55015:2013+A1:2015, EN 61000-3-2:2014, EN 61000-3-3:2013
Energy Star	Energy Star transient protection: Ballast or driver shall comply with ANSI/IEEE C62.41.1-2002 and ANSI/IEEE C62.41.2-2002, Category A operation. The line transient shall consist of seven strikes of a 100KHZ ring wave, 2.5KV level, for both common mode and differential mode.
EMS Category	Notes
EN 61000-4-2	Electrostatic Discharge (ESD): 8 kV air discharge, 4 kV contact discharge
EN 61000-4-3	Radio-Frequency Electromagnetic Field Susceptibility Test-RS
EN 61000-4-4	Electrical Fast Transient / Burst-EFT
EN 61000-4-5	Surge Immunity Test: AC Power Line: line to line 6 kV / 3kA, line to earth 10 kV / 12ohm
EN 61000-4-6	Conducted Radio Frequency Disturbances Test-CS
EN 61547	Electromagnetic Immunity Requirements Applies to Lighting Equipment

Note: the above test data are in the condition of 25 C ambient temperature, except for the marked temperature.

## Typical Applications

### ■. Constant Current Driver

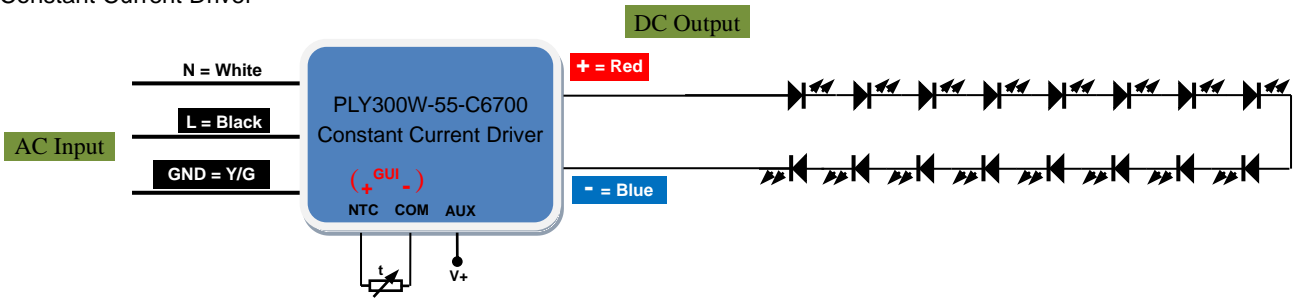

### ■. 0-10V or PWM Dimming Driver

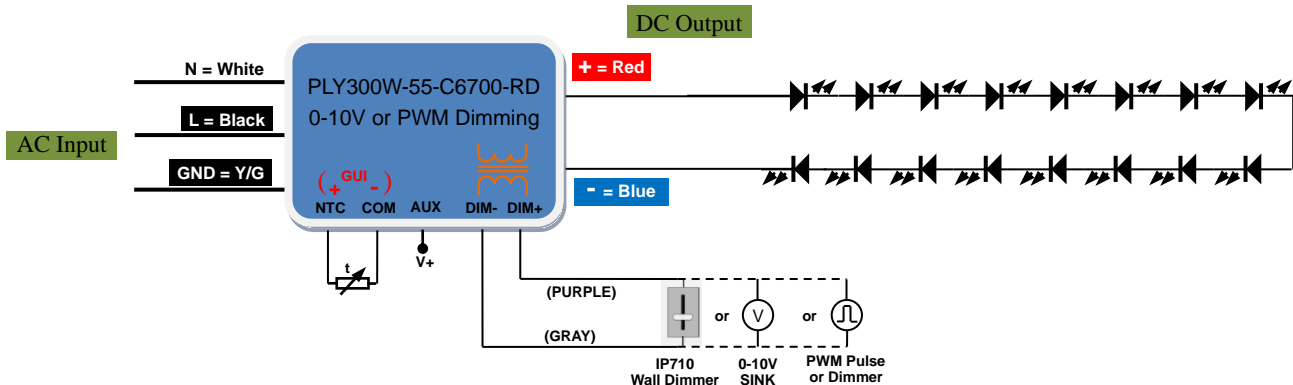

**0-10V Dimming Curve @ Minimum dimming set to 0**

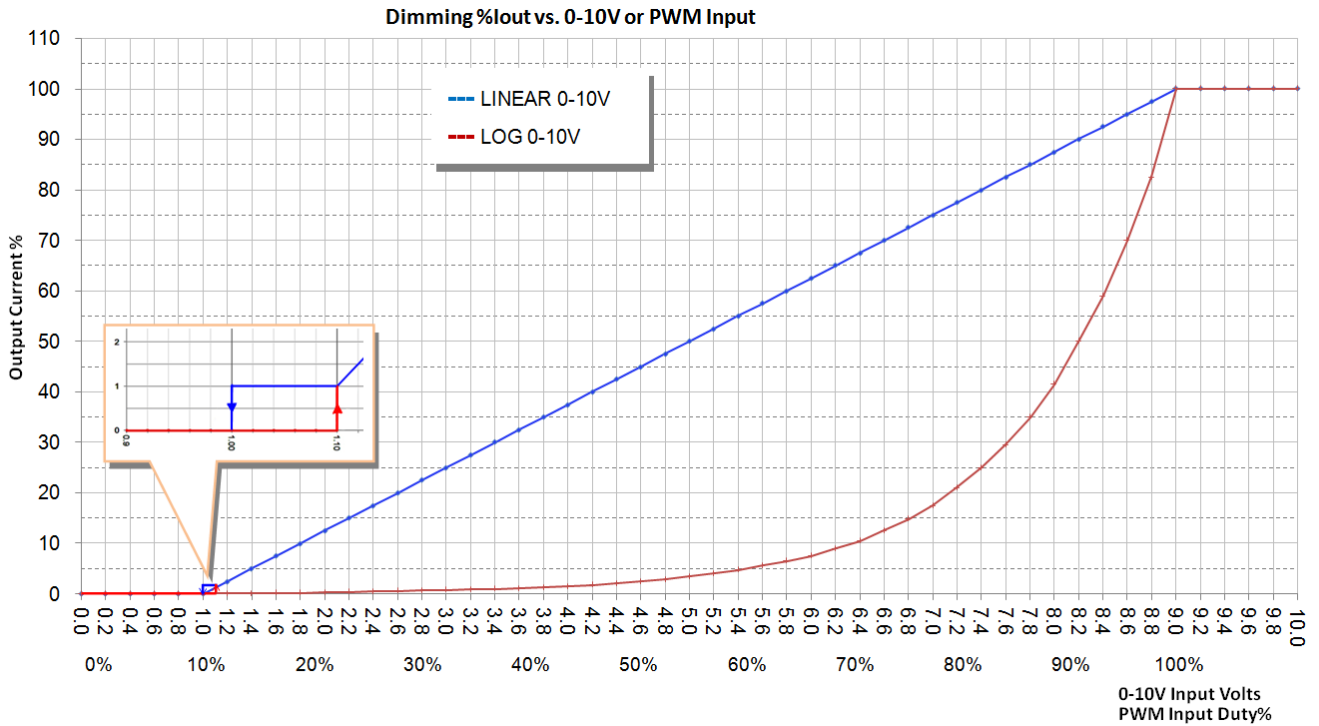

**NTC Current Control**

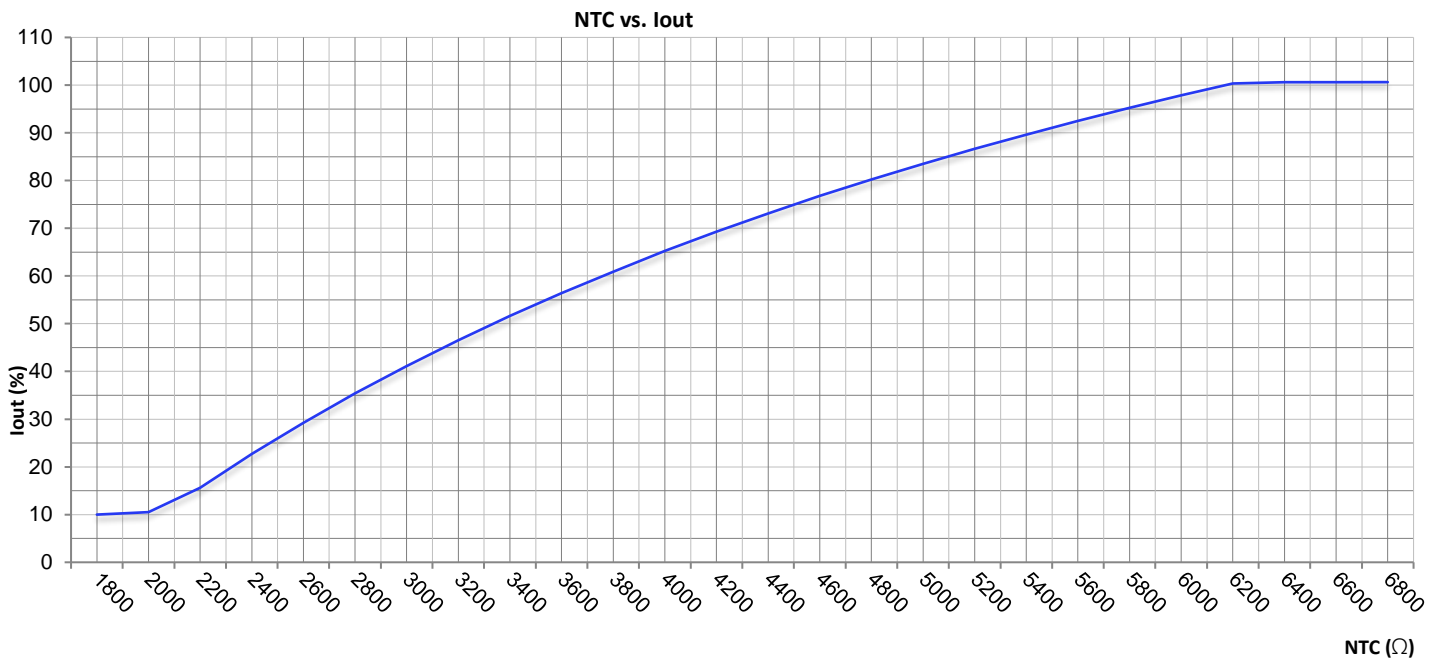

Note: Maximum dimming current is limited by NTC.  
 NTC values, NTC High, NTC Low and NTC Minimum Iout can be programmed.  
 Using YG Programmer USB interface & YG PC based GUI Software.  
 Default: NTC Low = 2.0K ~ 10% Iout, NTC High = 6.3K, 100% Iout.

Operating Window & DLC Window (PLY300W-55-C6700)

Output V - I Curve

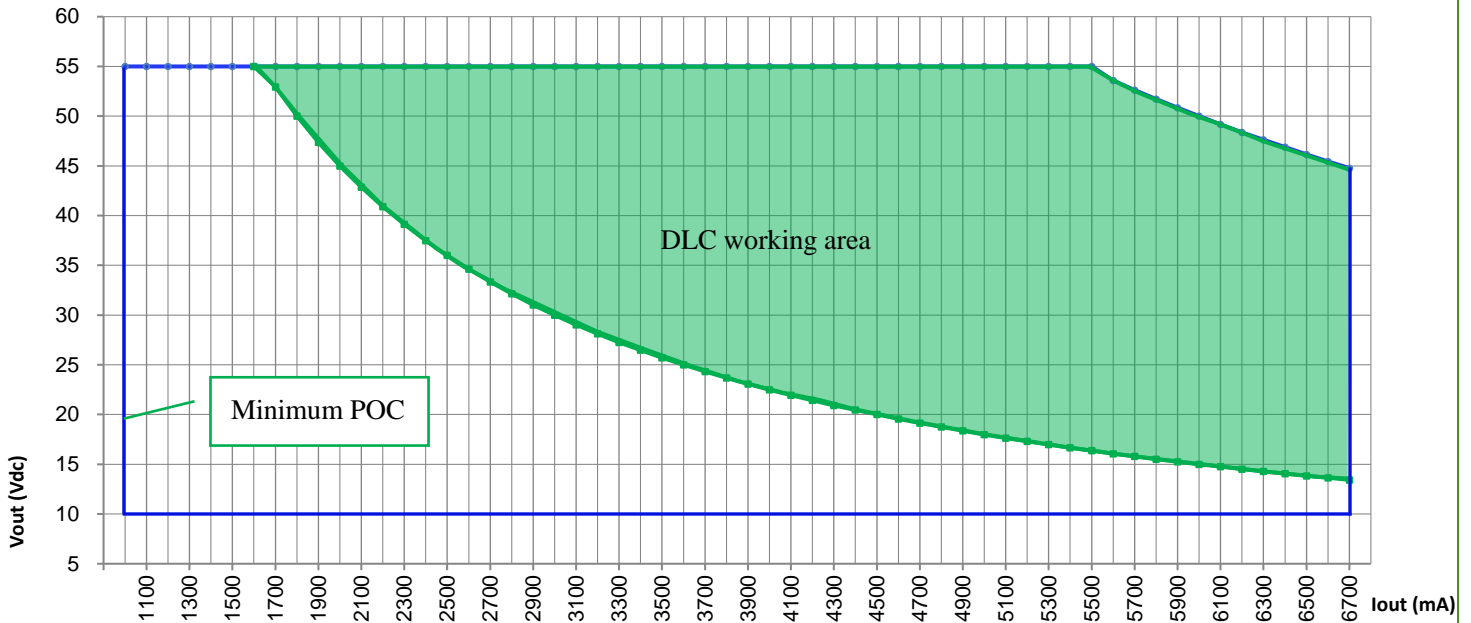

Operating Window & DLC Window (PLY300W-457-C1400)

Output V - I Curve

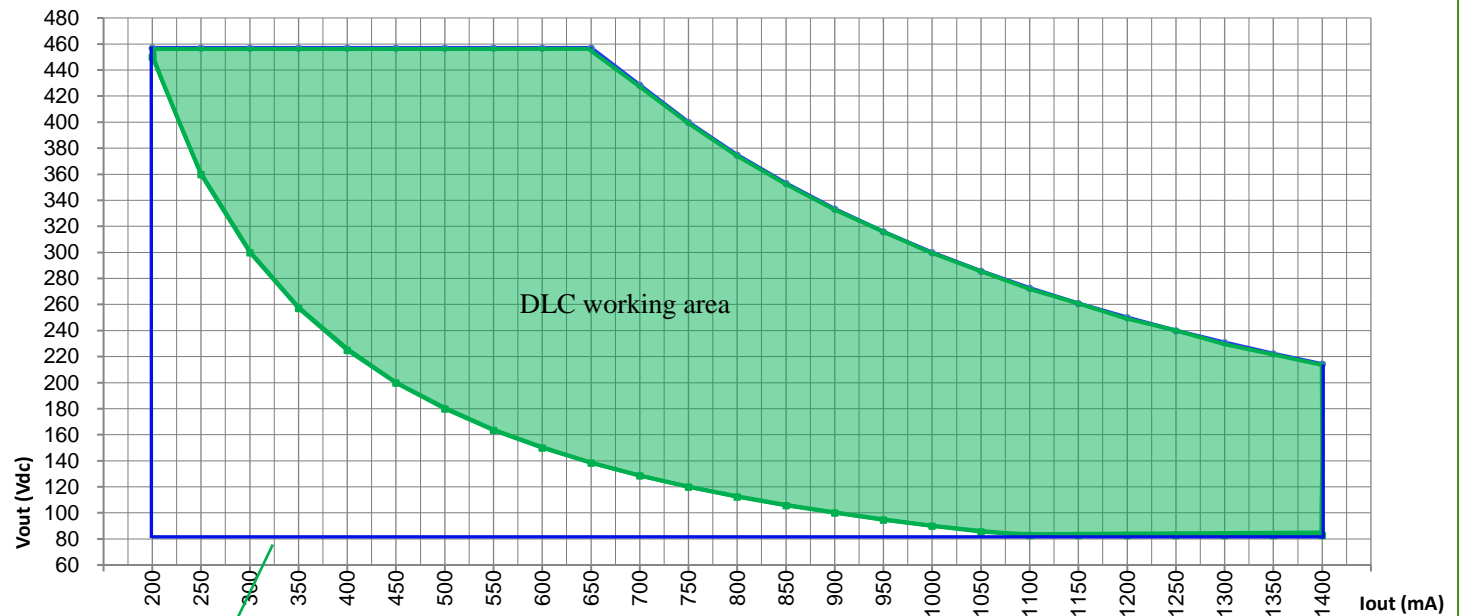

Minimum POC

- PF>0.9 and THD<20%, Window that meet DLC standards at input 120-277V range.
- Power Operating Window.

Note: When the output current is set, the output voltage is automatically limited within the curves.

**Output Current derating vs. TC Temperature Curve**

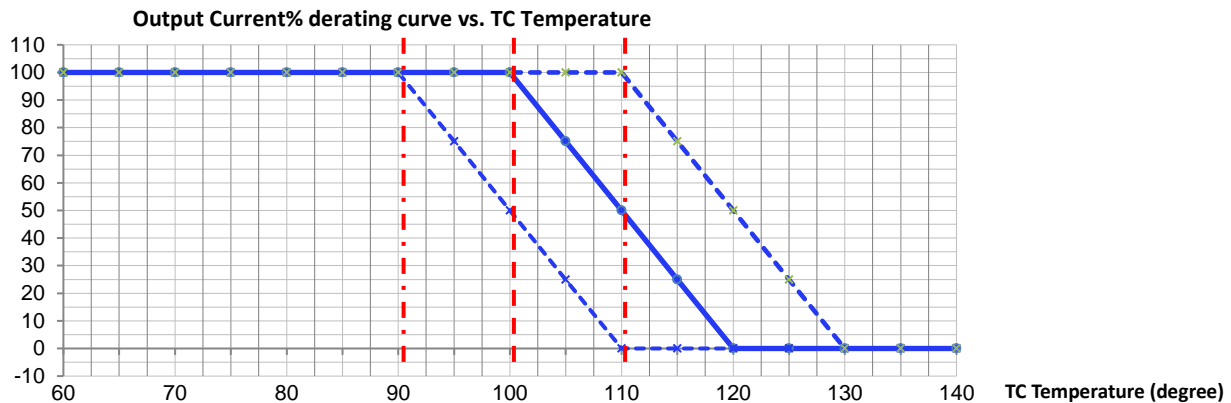

Note:

- ◆ The temperature control curve is the test result of the technical sample, and the product is not tested.
- ◆ Affected by the internal temperature distribution of the shell, the test temperature has a large error corresponding to the TC temperature.

**YG Programmer PC Based Software, USB Interface**

Programmable Output Current (POC): Programmable Iout from 200mA to 1400mA.

Programmable NTC Values:

Default: 2.0K ≈ 10% Iout, 6.3K = 100% Iout.

Programmable settings: NTC Minimum Level (%), NTC Minimum Ohms, NTC Maximum Ohms.

Programmable Minimum Dim Level: 0% (OFF) to 100% Iout programmed value.

**Programming Tool:**

The YG Programmer is a programming and configuration tool for YG intelligent programmable LED drivers. It consists of the YG programmer which is connected between the USB port of a computer and the LED driver being programmed, and the YG programmer software. The YG programmer software is a PC based graphical user interface that allows the user to program and configure the operating parameters of an YG Programmable LED Driver. This interface allows the operator to set the LED drivers output current within its specified range. In the increments specified. It also provides the ability to enable/disable and control features like “Dimming”, “Auxiliary Output”, “NTC Thermal Protection”, “Constant Lumen Module” & “End-of-life indicator” when available in the YG intelligent LED driver being programmed.

**YG Programmer:**

Is the physical USB unit connected between the USB port of a computer and the LED driver being programmed? This unit also provides all power required to the LED driver being programmed. No connection to an AC power source is required for programming the LED driver.

**YG Programmer Software:**

The YG Programmer software is the windows based GUI that allows the user to assign custom part number(s) to the LED driver being programmed. The user can then save the profile to a computer disk and recall as need. The user can then use the “Auto Program” feature to quickly program as many LED drivers with the saved profile as is required. Each driver programming simply requires a click of the mouse to program in a single step.

The YG Programmer software supports bar code scanners. The barcode scanner can be used to automate the programming of the attached LED driver. The barcodes scanner interface also provides an option to either enable or disable logging of the parameters to an excel file.

- PC programming mode is through the programmer PRG-01A two wires connected to the driver, by the GUI interface automatically complete the operation, there are engineering mode and factory mode. This mode requires the programmed driver to power on.

- NFC programming mode is through the programmer PRG-02A (hand-held) or PRG-02B (seat), automatically completed by the GUI interface, there are engineering mode and factory mode. This mode requires the antenna window of the driver to be near the programmer.

## GUI page

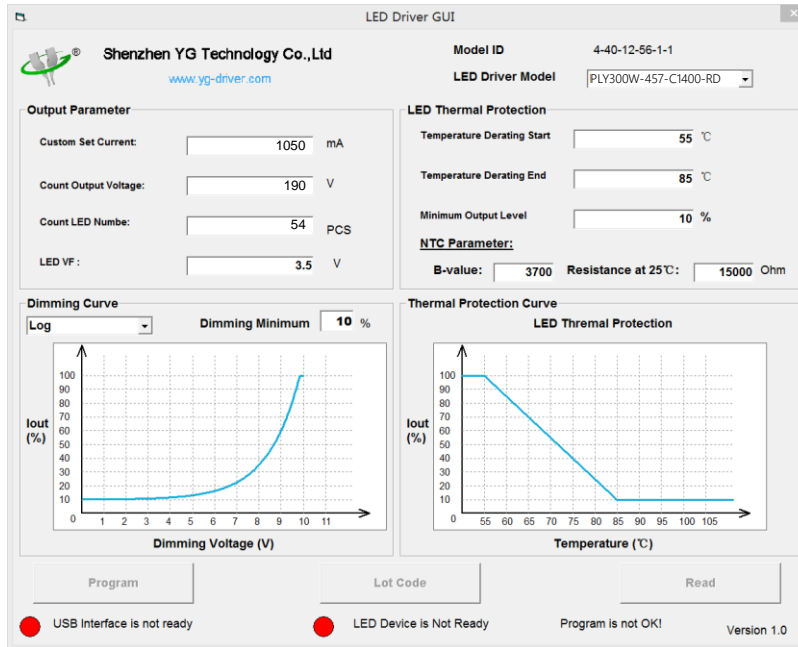

### Note:

- ◆ Custom designs available.
- ◆ Please consult with the factory.
- ◆ Specifications subject to change without notice.

## Output Current Soft-start

Output current soft-start are programmable (enable/disable) features. The default mode for features is disabled for out-of-the-box products. If these features are required, they must be checked ON in the programming software.

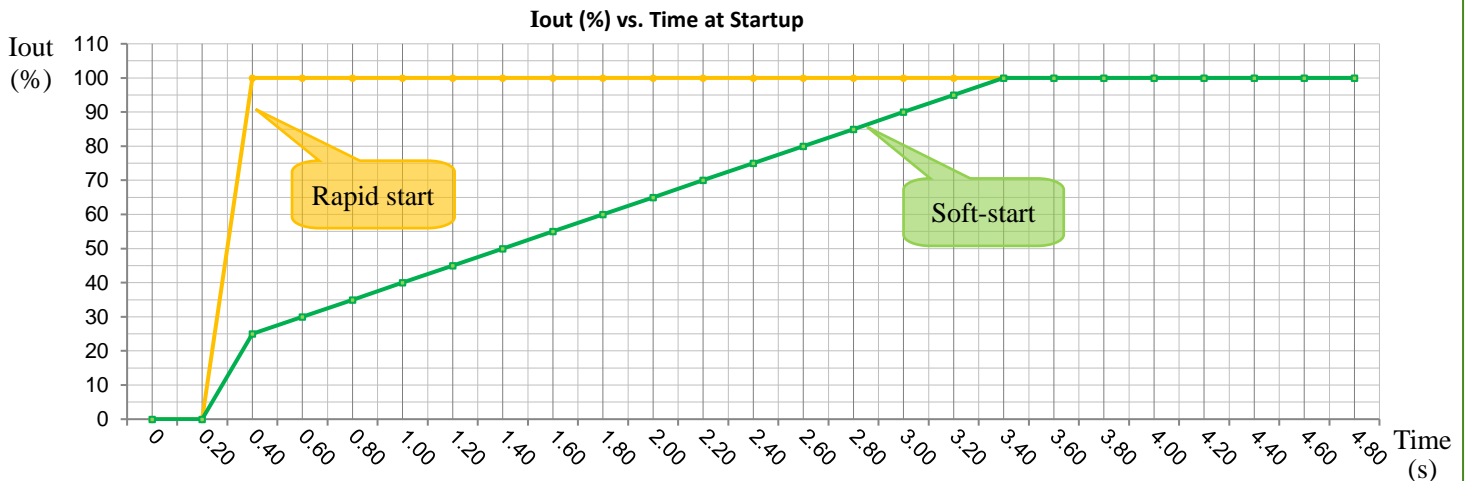

## Constant Lumen Module

The Constant Lumen Module feature of the PLY300W helps to maintain the required lumen output of the fixture at a constant level throughout its lifetime. In general LED's lumen output will depreciate over time and in order to maintain sufficient light level towards the end of lifetime, the LED's are driven at high current initially and will result in more energy consumption. The constant lumen module will give the flexibility to drive the LEDs at optimal driving current throughout its lifetime. This helps in energy savings, constant light output and enhanced reliability of the system.



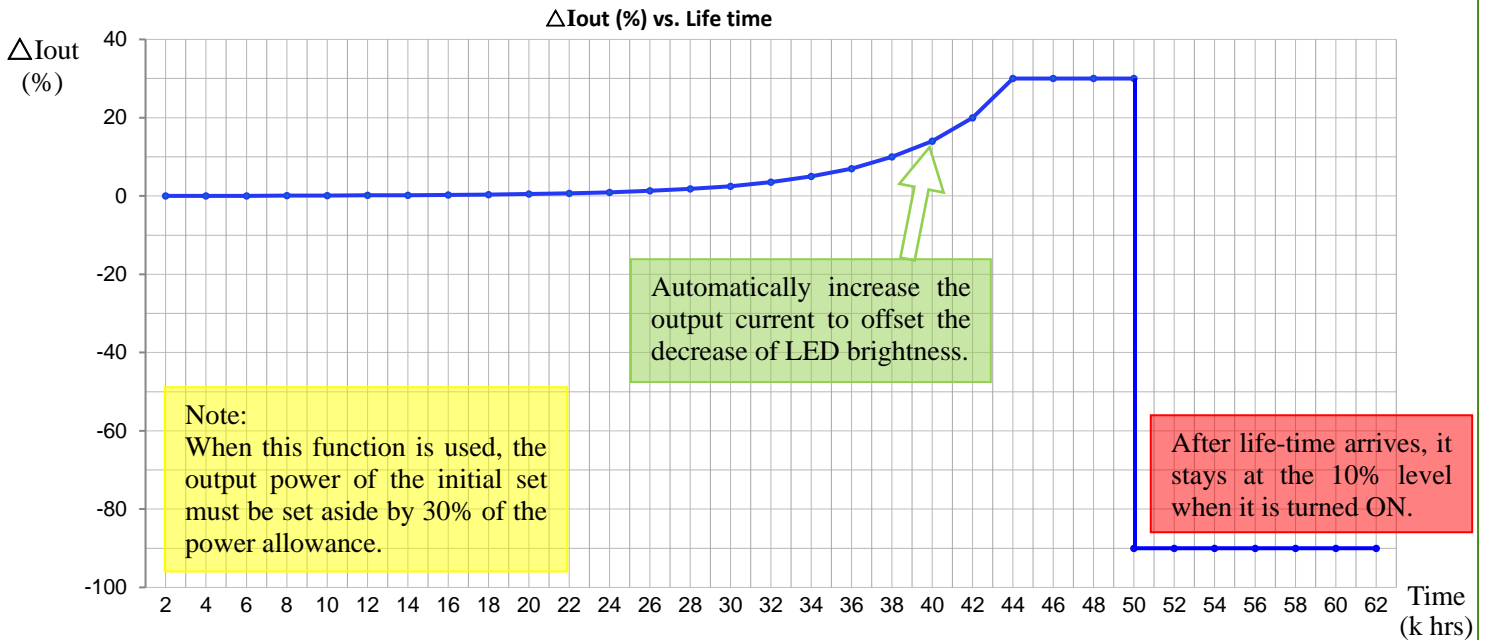

Note: A detailed step-by-step instructions are outlined in the Help section of the YG Programmer software.

## End-of-Life Indicator

The End-of-Life indicator helps the end user to receive a signal from the fixture indicating that it has reached its programmed life-time. After the LED driver reaches the programmed life-time, whenever it is turned ON, it stays at 'Dim' level (10%).

## Characteristic Curve

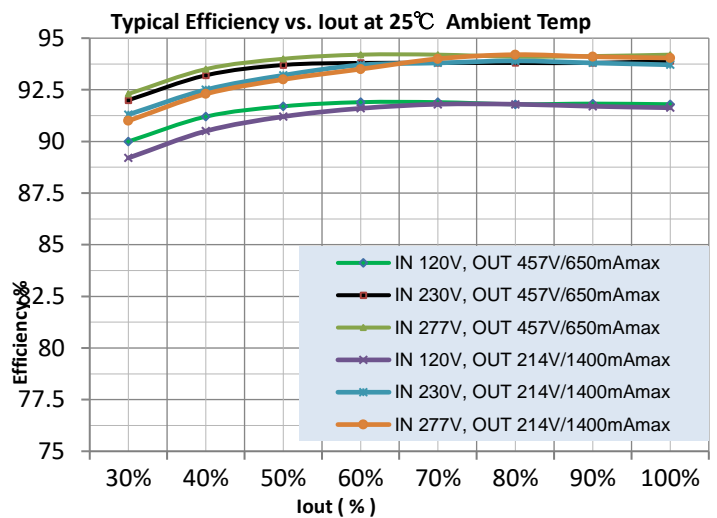
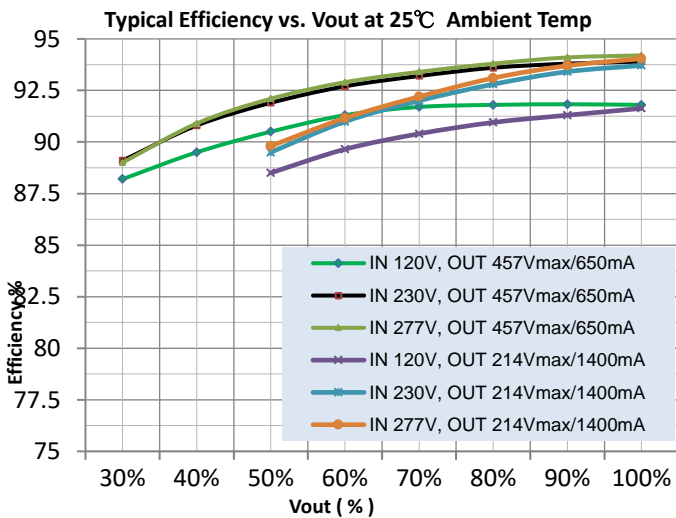

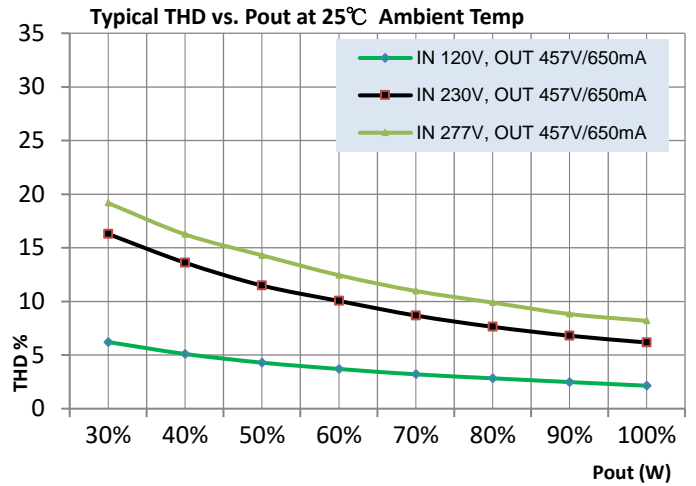
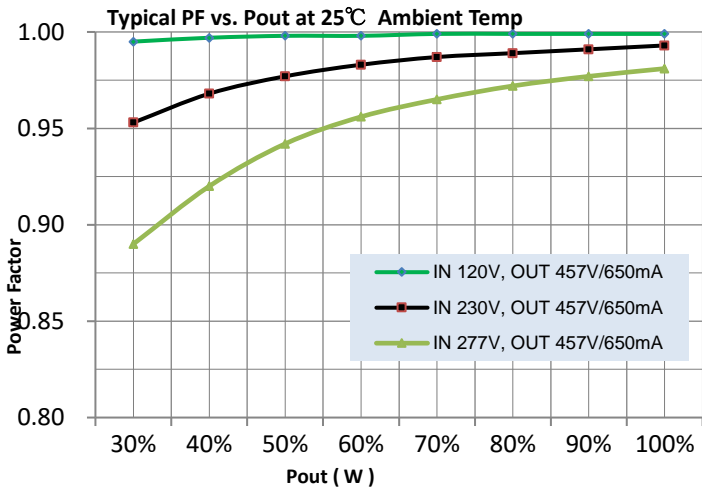

## Lifetime Curve

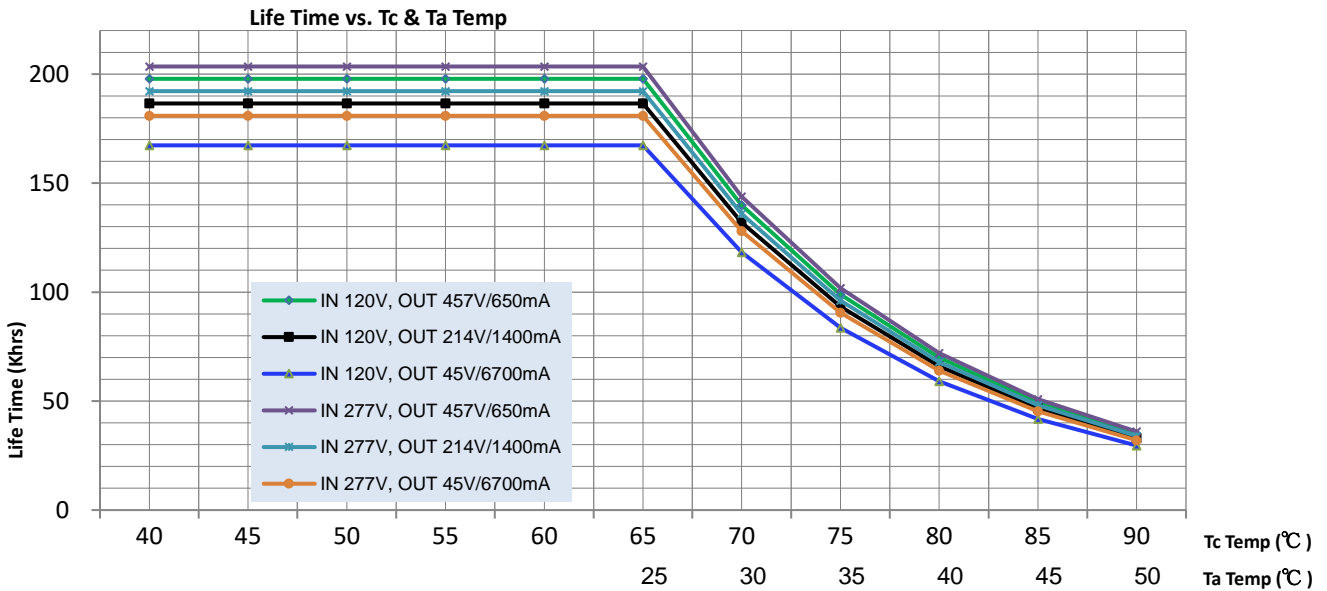

## Programming Connection Diagram

### PC Programming:

- GUI+ (red) → NTC (brown)
- GUI- (black) → COM (black)

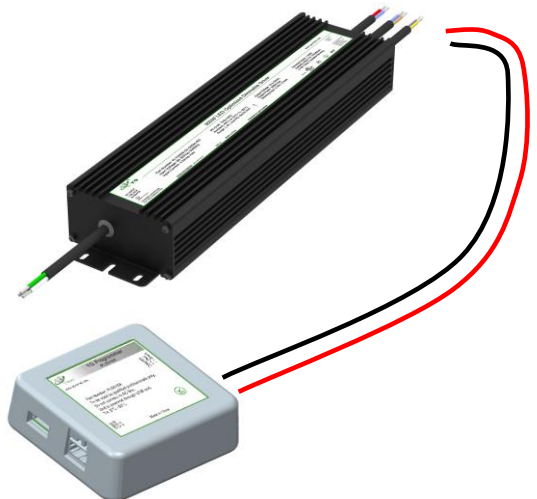
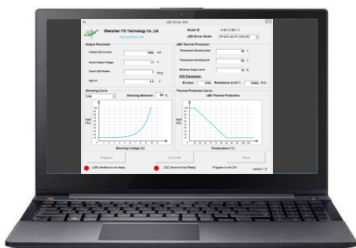

### NFC Programming:

The NFC programming window is located on the side of the driver, which should be close to the wireless emitter when programming.

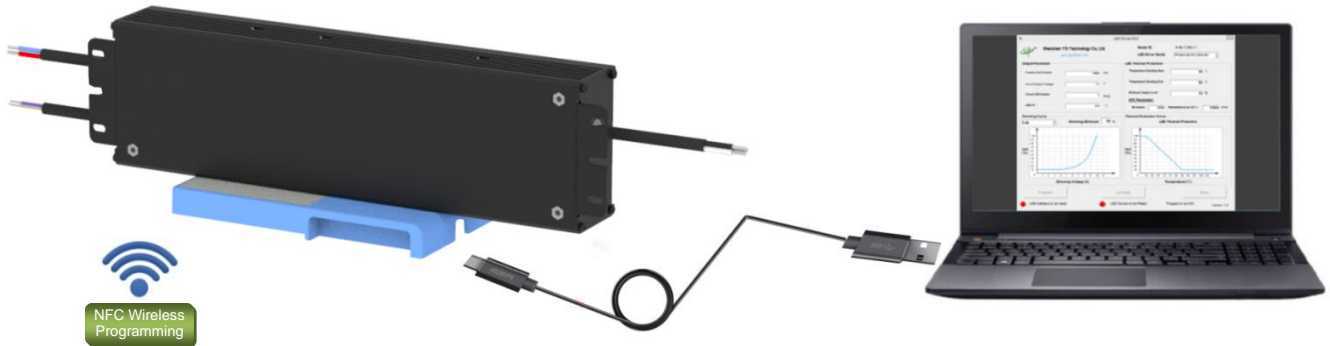

**Desktop NFC programmer - suitable for production line**

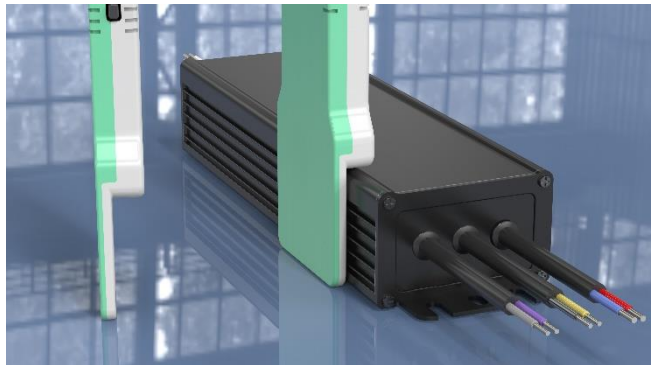
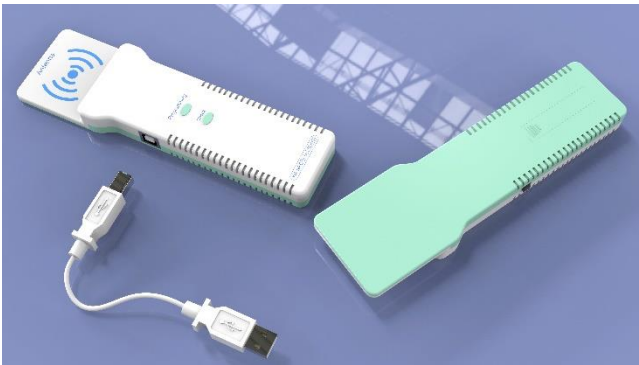

**Coming soon: Handheld NFC programmer (card type) - suitable for field use.  
(with two AAA batteries inside)**

## Installation

### ■ **UL Cable used in Dry & Damp Location:**

AC input for connection the three cores ANSI/UL2733/AWG18 temperature 105 °C core copper wire.

Cable Length: 150mm, stripping on the tin: 10mm.

Where: L — Black wire, N — White wire, GND — Yellow/Green wire.

DC output for connection the two cores ANSI/UL2733/AWG18 temperature 105 °C core copper wire.

Cable Length: 150mm, stripping on the tin: 10mm.

Where: DC+ — Red wire, DC- — Blue wire.

The dimmer control input is the two copper wires, ANSI/UL2733/AWG18 & temperature 105 °C.

Cable Length: 150mm, stripping on the tin: 10mm.

Where: DIM+ (0-10V or PWM) input — Purple wire, DIM- — Gray wire.

The GUI & NTC control input is the three copper wires, ANSI/UL2733/AWG18 & temperature 105 °C.

Cable Length: 150mm, stripping on the tin: 10mm.

Where: Aux V+ — Yellow wire, NTC (GUI+) — Brown wire, COM (GUI-, Aux V-) — Black wire.

Note: This function is only used in PC programmable products.



■ **UL Cable used in Wet Location:**

AC input for connection the three cores ANSI/SJTW(SJOW)/AWG18 temperature 105 °C core copper wire.

Cable Length: 150mm, stripping on the tin: 10mm.

SJOW Cable: L — Brown wire, N — Blue wire, GND — Yellow/Green wire.

DC output for connection the two cores ANSI/ SJTW(SJOW)/AWG18 temperature 105 °C core copper wire.

Cable Length: 180mm, stripping on the tin: 10mm.

SJOW Cable: DC+ — Brown wire, DC- — Blue wire.

The dimmer control input is the two copper wires, ANSI/ SJTW(SJOW)/AWG18 & temperature 105 °C.

Cable Length: 150mm, stripping on the tin: 10mm.

SJOW Cable: DIM+ (0-10V or PWM) input —Brown wire, DIM- —Blue wire.

The GUI & NTC control input is the three copper wires, ANSI/ SJTW(SJOW)/AWG18 & temperature 105 °C.

Cable Length: 150mm, stripping on the tin: 10mm.

SJOW Cable: Aux V+ — Yellow wire, NTC (GUI+) — Brown wire, COM (GUI-, Aux V-) — Blue wire

Note: This function is only used in PC programmable products.

SJOW is wet location cable.

■ **UL & CE, CB, ENEC Standard:**

AC input for connection the three cores copper wire connection.

Outdoor Type (IP67): IEC 60245 /VDE 0282-4 / H05RN-F (SJOW) 3G1.0mm<sup>2</sup> /300V.

Cable Length: 150mm, stripping on the tin: 10mm.

Where: L — Brown wire, N — Blue wire, GND — Yellow/Green wire.

DC output for connection the two core copper wire.

Outdoor Type (IP67): IEC 60245 /VDE 0282-4 / H05RN-F (SJOW) 2G1.0mm<sup>2</sup> /300V.

Cable Length: 150mm, stripping on the tin: 10mm.

Where: DC+ — Brown wire, DC- — Blue wire.

The dimmer control input is the two copper wires.

Outdoor Type (IP67): IEC 60245 /VDE 0282-4 / H05RN-F (SJOW) 2G1.0mm<sup>2</sup> /300V.

Cable Length: 150mm, stripping on the tin: 10mm.

Where: DIM+ (0-10V or PWM) input — Purple wire, DIM- — Blue wire.

The GUI & NTC control input is the three copper wires.

Outdoor Type (IP67): IEC 60245 /VDE 0282-4 / H05RN-F (SJOW) 2G1.0mm<sup>2</sup> /300V.

Cable Length: 150mm, stripping on the tin: 10mm.

Where: Aux V+ — Yellow wire, NTC (GUI+) — Brown wire, COM (GUI-, Aux V-) — Blue wire.

Note: This function is only used in PC programmable products.

H05RN-F (SJOW) is IP67 waterproof cable.

**Order ID**

P/N 1: PLY300W-457-C1400-RD

Description: 300W, Maximum output voltage 457 Vdc, Maximum output current 1400 mA, PC programming mode.

P/N 2: PLY300W-457-C1400-RDNFC

Description: 300W, Maximum output voltage 457 Vdc, Maximum output current 1400 mA, NFC programming mode.

## Product size

### NFC Programming model

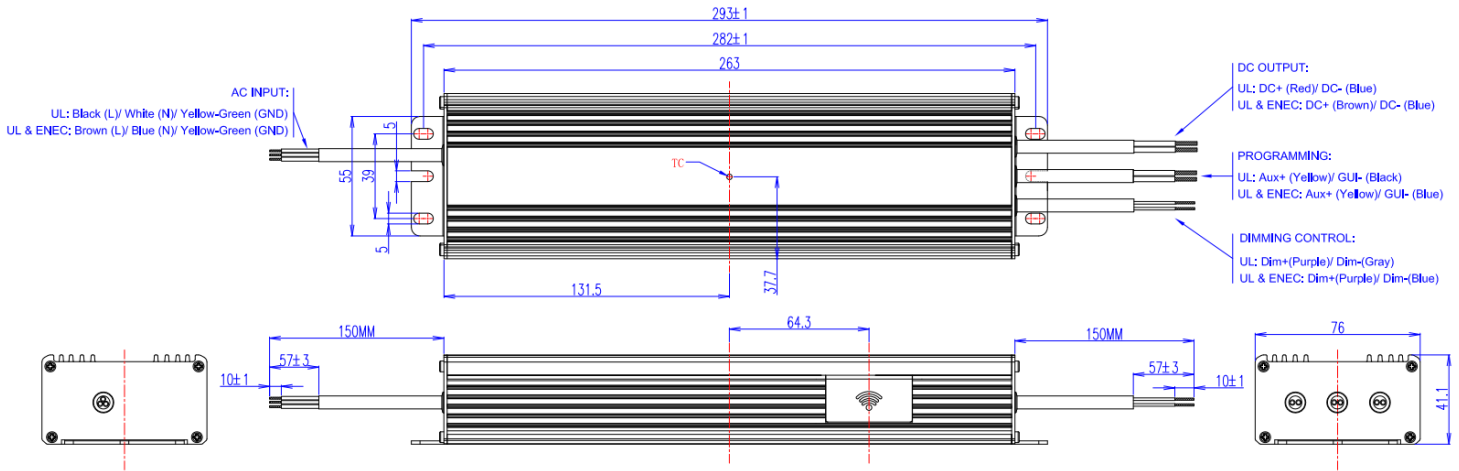

### PC Programming model

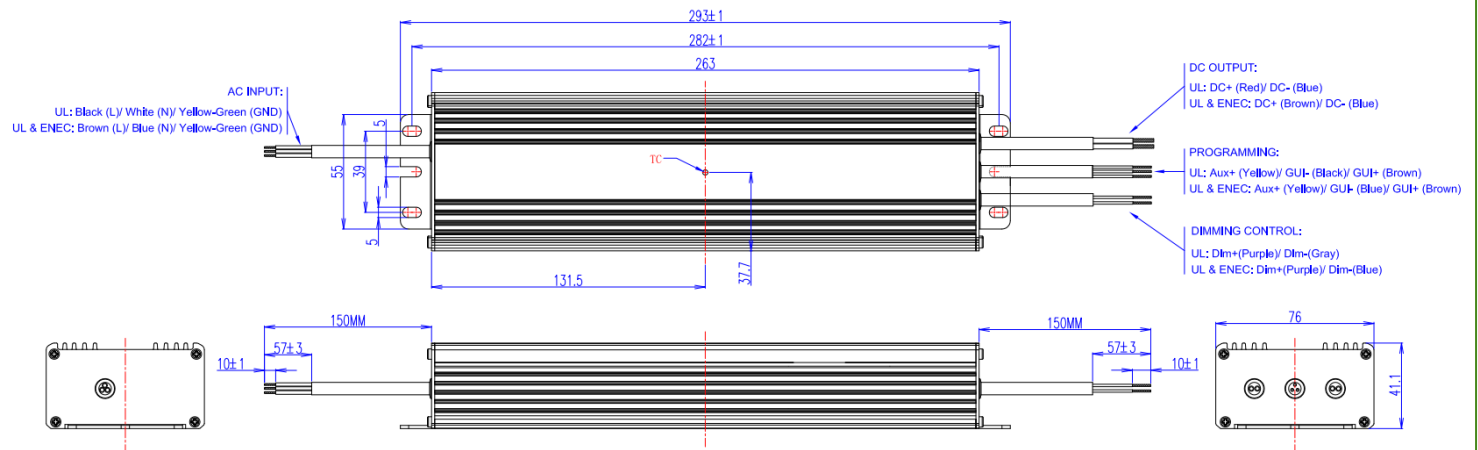

### Note :

- The independent LED drive conforms to the EMC standard.  
But it is not guaranteed to be qualified when the drive is mounted in the LED lamp.
- Please forgive us for any discrepancy due to the update of the specifications or the upgrade of the product.  
If you need the latest information, please contact our marketing department.
- It is not the same sample for UL and ENEC models.